

## Features and Benefits

- EX2 Technology**  
 Extended QE response
- TE cooling to -100°C**  
 Critical for elimination of dark current detection limit
- Fringe Suppression**  
 Reduced etaloning in NIR
- OptAcquire**  
 Optimize the highly flexible iXon<sub>3</sub> for different application requirements at the click of a button
- Count Convert**  
 Quantitatively capture and view data in electrons or incident photons. Real-time or post-processing
- RealGain™**  
 Absolute EMCCD gain selectable directly from a linear and quantitative scale
- EMCAL™**  
 Patented user-initiated self-recalibration of EM Gain
- Spurious Noise Filters**  
 Intelligent algorithms to filter clock induced charge events from the background. Real time or post-processing
- Cropped Sensor Mode**  
 Specialised acquisition mode for continuous imaging with fastest possible temporal resolution
- iCam**  
 The market-leading exposure time fast-switching software
- UltraVac™ \*1**  
 Critical for sustained vacuum integrity and to maintain unequalled cooling and QE performance, year after year
- Selectable amplifier outputs – EMCCD and conventional**  
 '2 in 1' flexibility. EMCCD for ultra-sensitivity at speed, conventional CCD for longer acquisitions
- Superior Baseline Clamp and EM stability**  
 Quantitative accuracy of dynamic measurements
- Enhanced Photon Counting Modes**  
 Intuitive single photon counting modes to overcome multiplicative noise, Real time or post-processing
- Built-in C-mount compatible shutter (optional)**  
 Easy means to record reference dark images

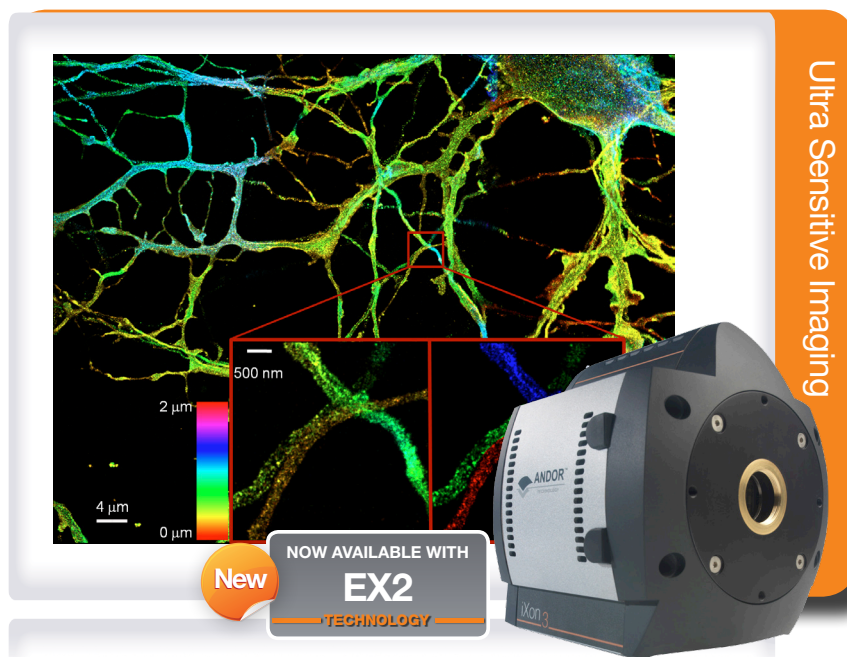

## Driving the Absolute Best From EMCCD Technology

Andor's iXon<sub>3</sub> 897 back-illuminated EMCCD has single photon detection capability combined with > 90% QE. This highly popular 512 x 512 frame transfer format delivers unequalled thermoelectric cooling down to -100°C, industry-lowest clock induced charge noise, and operates at 35 frames/sec (full resolution). New EX2 technology offers extended Quantum Efficiency performance.

Andor's 'overclocked' vertical shift capability offers distinct speed advantages and minimizes vertical smear. EMCCD and conventional CCD readout modes provide heightened application flexibility.

The iXon<sub>3</sub> 897 benefits from an advanced set of user-requested features, including OptAcquire, Count Convert, Spurious Noise Filters, Cropped Sensor Mode, Signal Averaging and enhanced Photon Counting capability. Patented EMCAL™ and RealGain™ provide sustained quantitative EM gain calibration.

## Specifications Summary <sup>\*2</sup>

Active pixels	512 x 512
Pixel size (W x H)	16 x 16 μm
Active area pixel well depth	180,000 e <sup>-</sup>
Gain register pixel well depth	800,000 e <sup>-</sup>
Maximum readout rate	10 MHz
Frame rate	35 - 7,980 fps
Read noise	< 1e <sup>-</sup> with EM gain
Maximum cooling	-100°C

## System Specifications <sup>\*2</sup>

<b>Model number</b>	<b>897</b>
<b>Sensor options</b>	#BV: Back Illuminated, standard AR coated BVF: Back Illuminated, standard AR coated with fringe suppression UVB: Back Illuminated, standard AR with additional lumogen coating #EX: Back illuminated, dual AR coated EXF: Back illuminated, dual AR coated with fringe suppression
<b>Active pixels</b>	512 x 512
<b>Pixel size</b>	16 x 16 $\mu\text{m}$
<b>Image area</b>	8.2 x 8.2 mm with 100% fill factor
<b>Minimum temperature, air cooled, ambient 20°C</b> Recirculator liquid cooling, coolant @ 22°C, >0.75l/min Chiller liquid cooling, coolant @ 10°C, >0.75l/min	-85°C -95°C -100°C
<b>Digitization</b>	True 14 bit @ 10, 5, 3 & 1 MHz readout rate (optional 16-bit available @ 1 MHz)
<b>Triggering</b>	Internal, External, External Start, External Exposure, Software Trigger
<b>System window type</b>	#BV and BVF sensors: UV-grade fused silica, 'Broadband VIS-NIR', wedged UVB sensor: UV-grade fused silica, 'Broadband VUV-NIR', unwedged #EX, EXF sensors: UV-grade fused silica, 'Broadband VUV-NIR', wedged
<b>Blemish specification</b>	Grade 1 sensor (CCD97), as defined by the sensor manufacturer e2v (see <a href="http://www.e2v.com">www.e2v.com</a> for further details)

## Advanced Performance Specifications <sup>\*2</sup>

<b>Dark current and background events <sup>*3,4</sup></b>																						
Dark current ( $e^-/\text{pixel}/\text{sec}$ ) @ -85°C	0.001																					
Spurious background (events/pix) @ 1000x gain / -85°C	0.005																					
<b>Active area pixel well depth</b>	180,000 $e^-$																					
<b>Gain register pixel well depth <sup>*5</sup></b>	800,000 $e^-$																					
<b>Pixel readout rates</b>	<table border="1"> <tr> <th></th> <th>Electron Multiplying Amplifier 10, 5, 3, 1 MHz</th> <th>Conventional Amplifier 3 &amp; 1 MHz</th> </tr> <tr> <td><b>Read noise (<math>e^-</math>) <sup>*6</sup></b></td> <td><b>Without Electron Multiplication</b></td> <td><b>With Electron Multiplication</b></td> </tr> <tr> <td>10 MHz through EMCCD amplifier</td> <td>49</td> <td>&lt; 1</td> </tr> <tr> <td>5 MHz through EMCCD amplifier</td> <td>42</td> <td>&lt; 1</td> </tr> <tr> <td>3 MHz through EMCCD amplifier</td> <td>32</td> <td>&lt; 1</td> </tr> <tr> <td>1 MHz through EMCCD amplifier</td> <td>21</td> <td>&lt; 1</td> </tr> <tr> <td>1 MHz through conventional amplifier</td> <td>6</td> <td>-</td> </tr> </table>		Electron Multiplying Amplifier 10, 5, 3, 1 MHz	Conventional Amplifier 3 & 1 MHz	<b>Read noise (<math>e^-</math>) <sup>*6</sup></b>	<b>Without Electron Multiplication</b>	<b>With Electron Multiplication</b>	10 MHz through EMCCD amplifier	49	< 1	5 MHz through EMCCD amplifier	42	< 1	3 MHz through EMCCD amplifier	32	< 1	1 MHz through EMCCD amplifier	21	< 1	1 MHz through conventional amplifier	6	-
	Electron Multiplying Amplifier 10, 5, 3, 1 MHz	Conventional Amplifier 3 & 1 MHz																				
<b>Read noise (<math>e^-</math>) <sup>*6</sup></b>	<b>Without Electron Multiplication</b>	<b>With Electron Multiplication</b>																				
10 MHz through EMCCD amplifier	49	< 1																				
5 MHz through EMCCD amplifier	42	< 1																				
3 MHz through EMCCD amplifier	32	< 1																				
1 MHz through EMCCD amplifier	21	< 1																				
1 MHz through conventional amplifier	6	-																				
<b>Linear absolute Electron Multiplier gain</b>	1 - 1000 times via RealGain™ (calibration stable at all cooling temperatures)																					
<b>Linearity <sup>*7</sup></b>	Better than 99%																					
<b>Vertical clock speed</b>	0.3 to 3.3 $\mu\text{s}$ (variable)																					

## Frame Rates (Standard Mode) <sup>\*8</sup>

Binning	Array size						
	512 x 512	256 x 256	128 x 128	64 x 64	512 x 100	512 x 32	512 x 1
1 x 1	35	68	132	251	168	456	2128
2 x 2	68	132	248	452	313	757	-
4 x 4	131	246	439	735	549	1111	-
8 x 8	231	426	699	1031	833	1351	-

## Frame Rates (Cropped Sensor Mode) <sup>\*8</sup>

Binning	Array size						
	256 x 256	128 x 128	64 x 64	32 x 32	512 x 100	512 x 32	512 x 1
1 x 1	69	395	988	2577	176	538	7980
2 x 2	136	743	1764	5400	342	1025	-
4 x 4	260	1327	2902	6068	649	1877	-
8 x 8	483	2184	4285	7375	1268	3209	-

## Quantum Efficiency Curves <sup>99</sup>

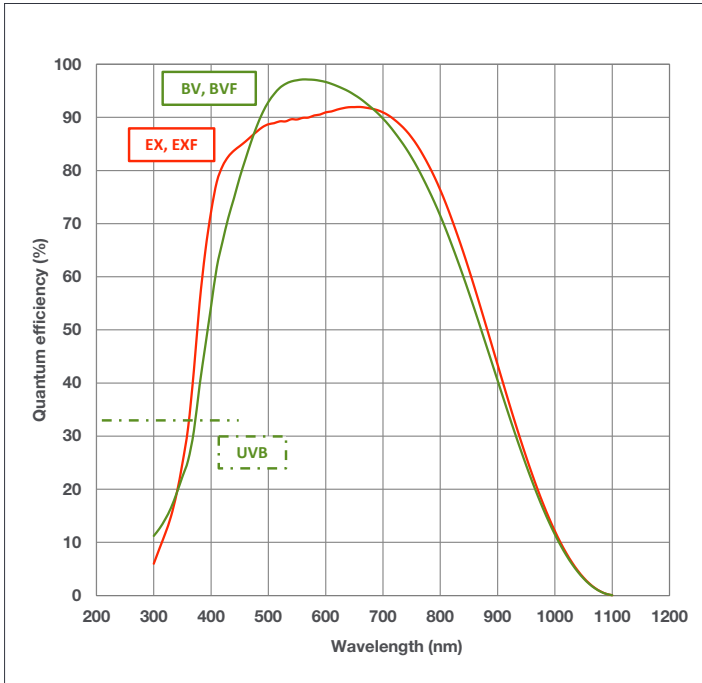

## QE vs. Fluorophores Curve

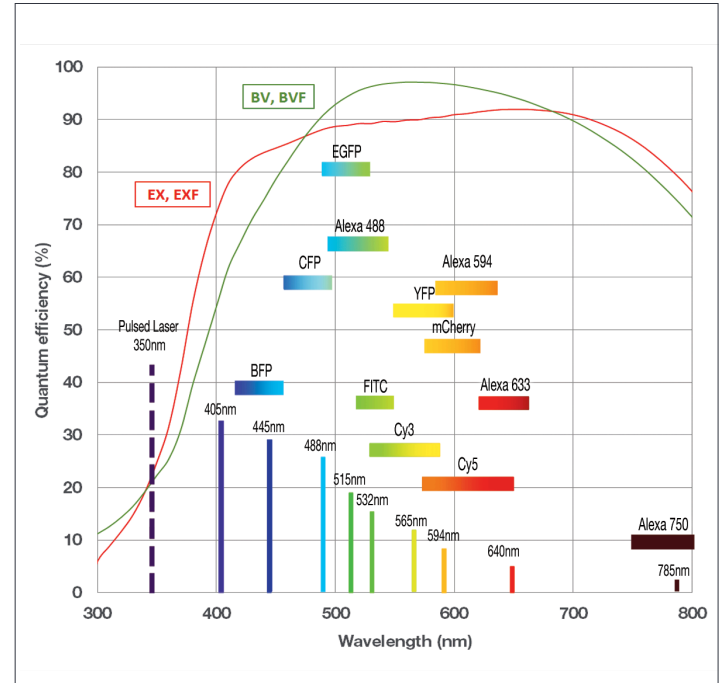

## Stability Plot

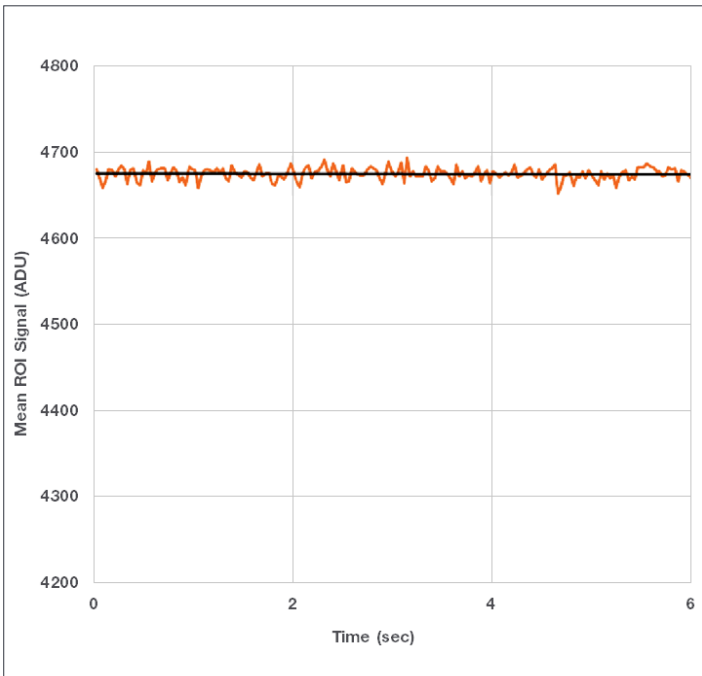

EM Gain stability in the iXon<sub>3</sub> 897. 200 frame kinetic series; frame transfer (overlapped) acquisition; 30 ms exposure time; x300 EM gain.

## Application Image

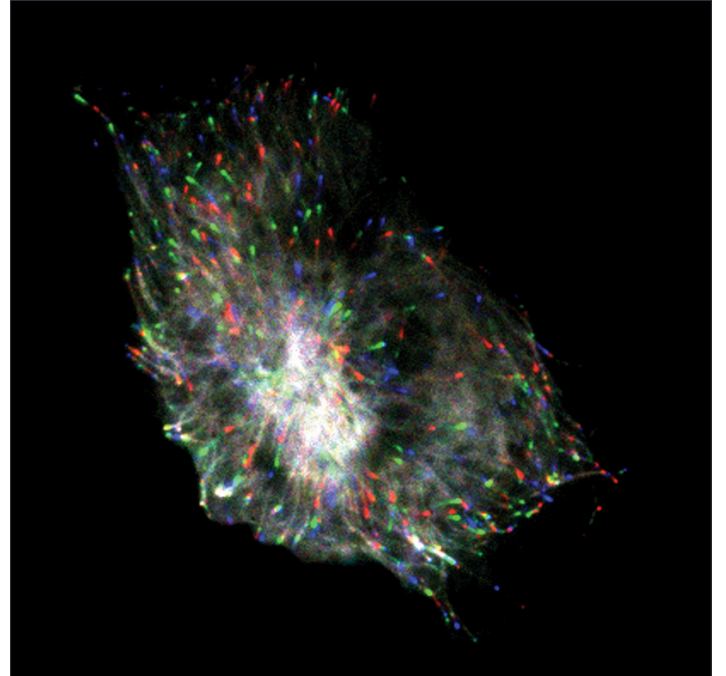

Composite triple color image of a microtubule protein (EB1-GFP) imaged with objective-type TIRFM (60x 1.45NA), using the 897 model. The different colors reveal the dynamics of the microtubules over time: frame 1 = red; frame 10 = green; frame 20 = blue.

Courtesy of Dr Derek Toomre, CINEMA laboratory, Dept. Cell Biology, Yale University.

## Creating The Optimum Product for You

How to customise the iXon<sub>3</sub> 897:

### Step 1.

Simply select from the 2 digitisation options that best suit your needs from the selection opposite.

### Step 2.

Please indicate if you require a shutter fitted to your iXon<sub>3</sub> 897.

### Step 3.

The iXon<sub>3</sub> 897 comes with 5 options for sensor types. Please select the sensor which best suits your needs.

### Step 4.

Please indicate alternative window option if required.

### Step 5.

Please indicate which software and controller card you require.

### Step 6.

For compatibility, please indicate which accessories are required.

### Step 6.

The following accessories are available:

**OPTOMASK** Optomask microscopy accessory, used to mask unwanted sensor area during Cropped Sensor mode acquisition.

**XW-RECR** Re-circulator for enhanced cooling performance

**ACC-XW-CHIL-160** Oasis 160 Ultra compact chiller unit

**OA-CNAF** C-mount to Nikon F-mount adapter

**OA-COFM** C-mount to Olympus adapter

**OA-CTOT** C-mount to T-mount adapter

DU-897 **D** - C **S** 0- **EXF**  
example shown

### Step 1.

#### Choose digitisation option

**D:** 10, 5, 3 & 1 MHz readout @ 14 bit  
**E:** 10, 5, & 3 MHz readout @ 14 bit and 1 MHz @ 16 bit

### Step 2.

#### Choose shutter option

**S:** Standard built-in mechanical shutter  
**0:** No shutter

### Step 3.

#### Choose sensor finish option

**#BV:** Back-illuminated, standard AR coated  
**BVF:** Back-illuminated, standard AR coated with fringe suppression  
**UVB:** Back Illuminated, standard AR with additional lumogen coating  
**#EX:** Back-illuminated, EX2 dual AR coated  
**EXF:** Back-illuminated, EX2 dual AR coated with fringe suppression

### Step 4.

#### Select alternative camera window (optional)

The standard window has been selected to satisfy most applications. However, other options are available. The alternative camera window code must be specified at time of ordering.

To view and select other window options please refer to the '**Camera Windows Supplementary Specification Sheet**' which gives the transmission characteristics, product codes and procedure for entering the order. Further detailed information on the windows can be found in the Technical note – '**Camera Windows: Optimizing for Different Spectral Regions**'.

### Step 5.

The iXon<sub>3</sub> 897 requires at least one of the following controller card and software options:

**CCI-23** PCI Controller card.

**CCI-24** PCIe Controller card.

**Solis Imaging A** 32-bit application compatible with 32 and 64-bit Windows (XP, Vista, 7 and 8) offering rich functionality for data acquisition and processing. AndorBasic provides macro language control of data acquisition, processing, display and export.

**Andor SDK** A software development kit that allows you to control the Andor range of cameras from your own application. Available as 32 and 64-bit libraries for Windows (XP, Vista, 7 and 8), compatible with C/C++, C#, Delphi, VB6, VB.NET, LabVIEW and Matlab. Linux SDK compatible with C/C++.

**Andor iQ** A comprehensive multi-dimensional imaging software package. Offers tight synchronization of EMCCD with a comprehensive range of microscopy hardware, along with comprehensive rendering and analysis functionality. Modular architecture for best price/performance package on the market.

#### Third party software compatibility

Drivers are available so that the iXon<sub>3</sub> range can be operated through a large variety of third party imaging packages. See Andor web site for detail: [andor.com/software/](http://andor.com/software/)

## Product Drawings

Dimensions in mm [inches]

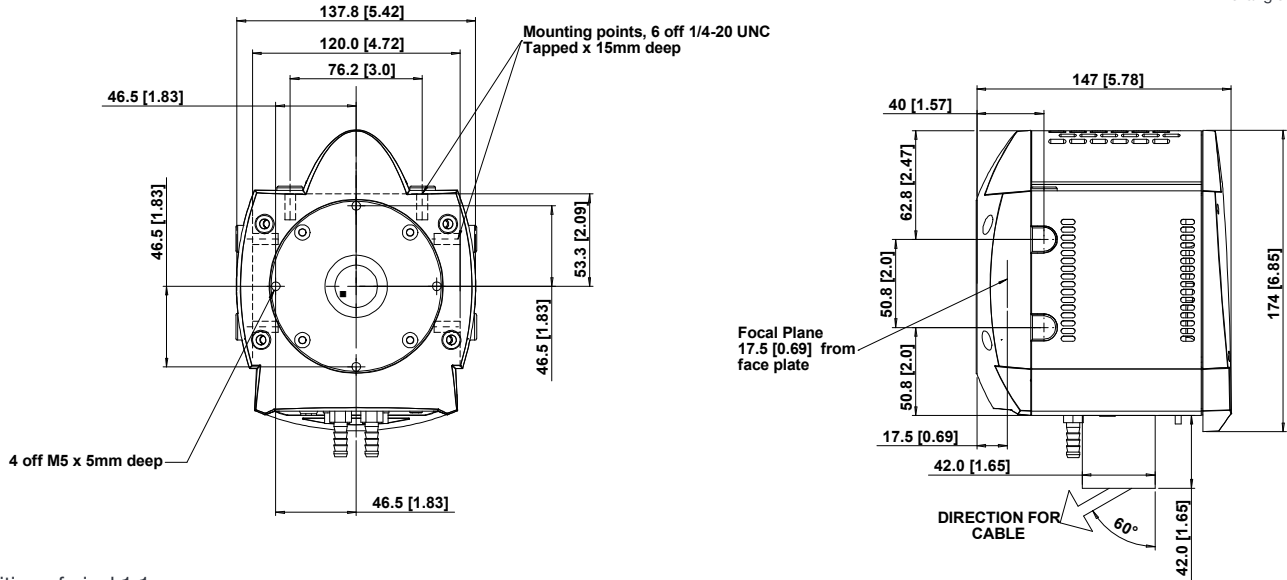
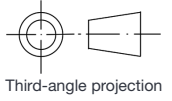

■ = position of pixel 1,1

Weight: 3.4 kg [7 lb 8 oz]

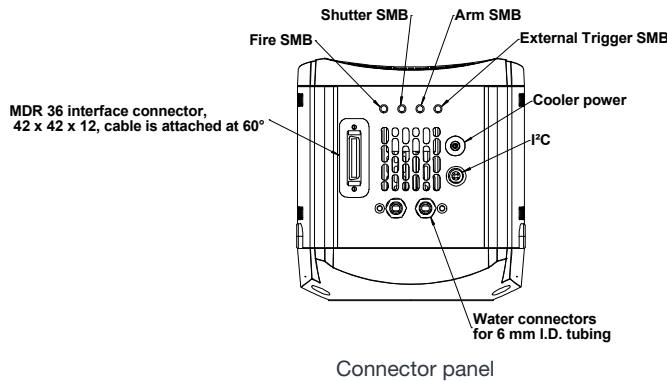

## Connecting to the iXon<sub>3</sub>

### Camera Control

Connector type: PCI or PCIe

### TTL / Logic

Connector type: SMB, provided with SMB - BNC cable  
 Fire (Output), Shutter (Output), Arm (Output), External Trigger (Input)

### I<sup>2</sup>C connector

Compatible with Fischer SC102A053-130, pinouts as follow:  
 1 = I<sup>2</sup>C Clock, 2 = I<sup>2</sup>C Data, 3 = Ground, 4 = +5 Vdc

### Minimum cable clearance required at rear of camera

90 mm

## Typical Applications

Single Molecule Detection
Super Resolution (PALM, STORM)
TIRF Microscopy
Spinning Disk Confocal Microscopy
Selective/Single Plane Illumination Microscopy (SPIM)
Calcium Flux
Whole Genome Sequencing
FRET / FRAP
Microspectroscopy / Hyperspectral Imaging
Lucky Astronomy
Single Photon Counting





## Order Today

Need more information? At Andor we are committed to finding the correct solution for you. With a dedicated team of technical advisors, we are able to offer you one-to-one guidance and technical support on all Andor products. For a full listing of our local sales offices, please see: [andor.com/contact](http://andor.com/contact)

### Our regional headquarters are:

#### Europe

Belfast, Northern Ireland  
Phone +44 (28) 9023 7126  
Fax +44 (28) 9031 0792

#### Japan

Tokyo  
Phone +81 (3) 3518 6488  
Fax +81 (3) 3518 6489

#### North America

Connecticut, USA  
Phone +1 (860) 290 9211  
Fax +1 (860) 290 9566

#### China

Beijing  
Phone +86 (10) 5129 4977  
Fax +86 (10) 6445 5401

### Items shipped with your camera:

- 1x PCI or PCIe controller card + SATA adapter
- 1x Controller card splitter/fly-lead (if required)
- 1x 3m iXon<sub>3</sub> detector cable
- 2x 2m SMB - BNC connection cables
- 1x Power supply with mains cable
- 1x Quick launch guide
- 1x CD containing Andor user manuals
- 1x Individual system performance booklet
- 1x Disposable ESD wrist strap

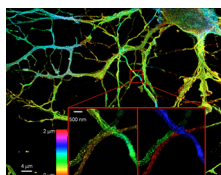

Front cover image: A large scale 3D STORM image of a cultured hippocampal neuron colored in z. Courtesy of Melike Lakadamyali, Institute of Photonic Sciences, ICFO, Barcelona, Spain and Hazen Babcock from Harvard University, Cambridge, MA

### Footnotes: Specifications are subject to change without notice

1. Assembled in a state-of-the-art cleanroom facility, Andor's UltraVac™ vacuum process combines a permanent hermetic vacuum seal (no o-rings), with a stringent protocol to minimize outgassing, including use of proprietary materials.
2. Figures are typical unless otherwise stated.
3. The dark current measurement is averaged over the sensor area excluding any regions of blemishes.
4. Using Electron Multiplication the iXon<sub>3</sub> is capable of detecting single photons, therefore the true camera detection limit is set by the number of 'dark' background events. These events consist of both residual thermally generated electrons and Clock Induced Charge (CIC) electrons (also referred to as Spurious Noise), each appearing as random single spikes above the read noise floor.  
A thresholding scheme is employed to count these single electron events and is quoted as a probability of an event per pixel. Acquisition conditions are full resolution and max frame rate (10 MHz readout; frame-transfer mode; 0.5 μs vertical clock speed; x 1000 EM gain; 10 ms exposure; -85°C).
5. The EM register on CCD97 sensors has a linear response up to ~400,000 electrons and a full well depth of ~800,000 electrons.
6. Readout noise is for the entire system. It is a combination of sensor readout noise and A/D noise. Measurement is for Single Pixel readout with the sensor at a temperature of -75°C and minimum exposure time under dark conditions. Under Electron Multiplying conditions, the effective system readout noise is reduced to sub 1e<sup>-</sup> levels.
7. Linearity is measured from a plot of counts vs exposure time under constant photon flux up to the saturation point of the system.
8. All measurements are made with 0.3 μs vertical clock speed. It also assumes internal trigger mode of operation.
9. Quantum efficiency of the sensor at 20°C, as supplied by the sensor manufacturer.

### Recommended Computer Requirements:

- 3.0 GHz single core or 2.6 GHz multi core processor
- 2 GB RAM
- 100 MB free hard disc to install software (at least 1 GB recommended for data spooling)
- PCI 2.2 or PCIe slot
- 10,000 rpm SATA hard drive preferred for extended kinetic series
- Windows (XP, Vista, 7 and 8) or Linux

### Operating & Storage Conditions

- Operating Temperature: 0°C to 30°C ambient
- Relative Humidity: < 70% (non-condensing)
- Storage Temperature: -25°C to 50°C

### Power Requirements

- 110 - 240 VAC, 50/60 Hz



LIXon3897SS 0114 R1